

AIREDALE

Lisa Richardson

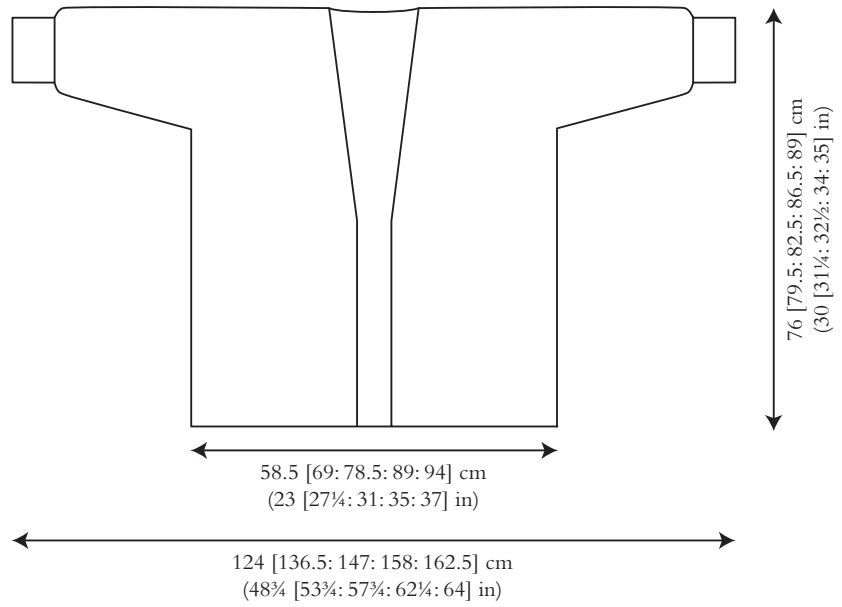

Sample size 71-86 cm (28-34")



SIZE

To fit chest (cm/in)

71-86	91-107	112-127	132-142	147-157
28-34	36-42	44-50	52-56	58-62

Actual measurement of garment at lower edge

117	138.5	157	178.5	187.5
46	54½	61¾	70¼	73¾

YARN

Alpaca Soft DK (50gm)

A Classic Brown 204

7	9	10	12	12
---	---	----	----	----

B Silver 231

2	2	2	3	3
---	---	---	---	---

C Naples Blue 217

3	4	4	5	5
---	---	---	---	---

D Autumn Gold 220

7	8	10	11	12
---	---	----	----	----

NEEDLES

1 pair 3¼mm (no 10) (US 3) needles

1 pair 4mm (no 8) (US 6) needles

3¼mm (no 10) (US 3) circular needle at least 120 cm long

4mm (no 8) (US 6) circular needle at least 120 cm long

TENSION

25 sts and 26 rows to 10 cm measured over patterned st st using 4mm (US 6) needles.

AUSTONLEY

Chloe Thurlow



YARN

Alpaca Soft DK (50gm)

A Trench Coat 202	9
B Classic Brown 204	5
C Autumn Gold 220	2
D Naples Blue 217	1
E Hunter Green 214	1

NEEDLES

4mm (no 8) (US 6) circular needle no more than 50 cm long

TENSION

24 sts and 27 rows to 10 cm measured over patterned st st using 4mm (US 6) needles.

FINISHED SIZE

Completed scarf is 30 cm (11¾ in) wide and 198.5 cm (78¼ in) long.

RIBBLE DEN

ARNE & CARLOS



Felted Tweed (50gm)

A Fjord 218	1	E Peach 212	1
B Black 211	1	F Alabaster 197	1
C Duck Egg 173	1	G Celadon 184	1
D Stone 190	1	H Pine 158	1

NEEDLES

3¼mm (no 10) (US 3) circular needle no more than 40 cm long

3¾mm (no 9) (US 5) circular needle no more than 40 cm long

TENSION

26 sts and 27 rounds to 10 cm measured over patterned st st using 3¾mm (US 5) circular needle.

BANKFIELD

Erika Knight



Sample size 81-86 cm (32-34")

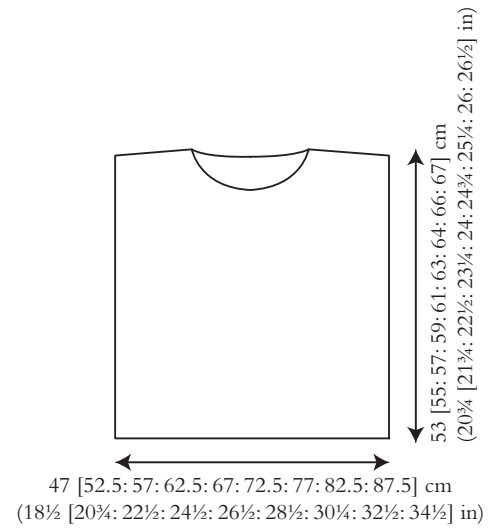
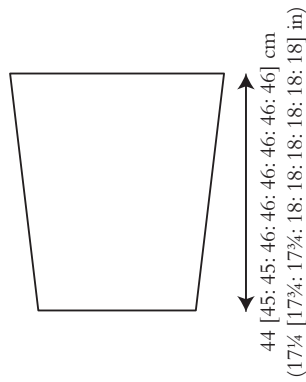

SIZE

To fit chest (cm/in)

71-76 81-86 91-97 102-107 112-117 122-127 132-137 142-147 152-157

28-30 32-34 36-38 40-42 44-46 48-50 52-54 56-58 60-62

Actual chest measurement of garment

93.5 104.5 113.5 124.5 133.5 144.5 153.5 164.5 175.5

36 3/4 41 1/4 44 3/4 49 52 1/2 57 60 1/2 64 3/4 69

YARN

Felted Tweed (50gm)

A Bilberry 151

2 2 2 2 2 3 3 3 3

B Barn Red 196

3 4 4 4 5 5 5 6 6

C Ginger 154

1 1 1 1 1 1 2 2 2

D Cumin 193

1 1 1 1 1 1 1 1 1

E Stone 190

1 1 1 1 2 2 2 2 2

F Cinnamon 175

1 1 1 1 1 1 1 1 1

Oddments of same yarn in shades of your choice for embroidery
(photographed sample uses shades listed above)

NEEDLES

1 pair 3 1/2 mm (no 10/9) (US 4) needles

1 pair 4 mm (no 8) (US 6) needles

3 1/2 mm (no 10/9) (US 4) circular needle at least 60 cm long

TENSION

22 sts and 30 rows to 10 cm measured over st st using 4 mm (US 6) needles.

BENYONS

Martin Storey



Sample size 81-86 cm (32-34")

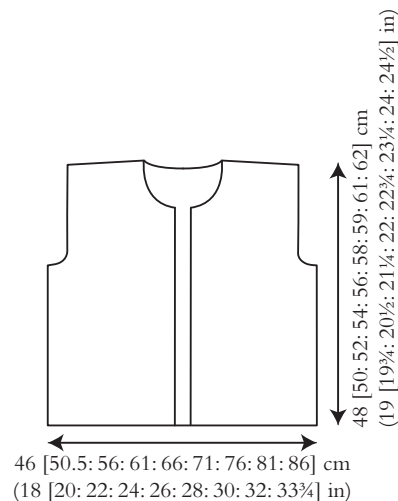
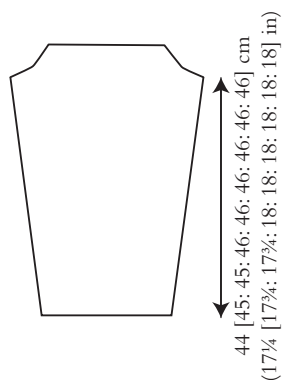

SIZE

To fit chest (cm/in)

71-76 81-86 91-97 102-107 112-117 122-127 132-137 142-147 152-157

28-30 32-34 36-38 40-42 44-46 48-50 52-54 56-58 60-62

Actual chest measurement of garment

91.5 101 111.5 122.5 131.5 142.5 151.5 162.5 171.5

36 39½ 44 48½ 51½ 56 59½ 64 67½

YARN

Alpaca Soft DK (50gm)

A Autumn Gold 220

5 6 7 7 8 9 9 10 11

B Charcoal 211

3 4 4 5 5 5 6 6 6

C Rainy Day 210

4 4 4 5 5 6 6 6 7

NEEDLES

1 pair 3¼mm (no 10) (US 3) needles

1 pair 4mm (no 8) (US 6) needles

Two long double-pointed 3¼mm (no 10) (US 3) needles (optional)

BUTTONS – 5 x TGB4915 (coco shell 18mm) from Textile Garden.

Please see information page for contact details.

TENSION

26 sts and 37 rows to 10 cm measured over patt using 4mm (US 6) needles.

BRAMLEY

Lisa Richardson



Sample size 81-86 cm (32-34")

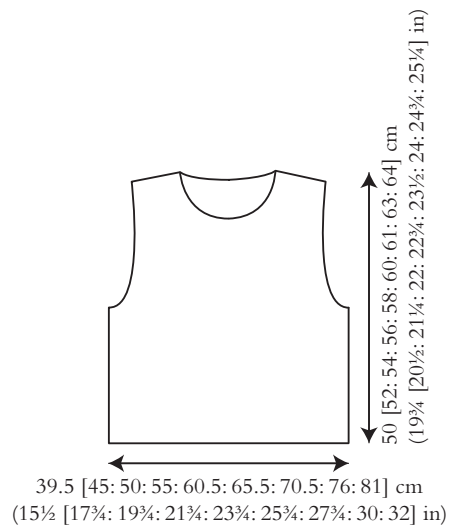

SIZE

To fit chest (cm/in)

71-76 81-86 91-97 102-107 112-117 122-127 132-137 142-147 152-157

28-30 32-34 36-38 40-42 44-46 48-50 52-54 56-58 60-62

Actual chest measurement of garment

79.5 89.5 100 110.5 120.5 131 141.5 152 162

31¼ 35¼ 39¼ 43½ 47½ 51½ 55¼ 59¼ 63¼

YARN

Felted Tweed (50gm)

A Aluminium 210

2 2 2 3 3 3 3 4 4

B Watery 152

1 1 1 1 1 1 1 1 2

C Sulfur 220

1 1 1 1 1 1 2 2 2

D Carbon 159

1 1 1 1 1 1 1 1 1

E Tawny 186

1 1 1 1 1 1 1 1 1

F Barbara 200

1 1 1 1 1 1 2 2 2

G Alabaster 197

1 1 1 1 1 1 1 1 1

NEEDLES

1 pair 3¼mm (no 10) (US 3) needles

1 pair 4mm (no 8) (US 6) needles

TENSION

27 sts and 27 rows to 10 cm measured over patterned st st using 4mm (US 6) needles.

BRIDGE

Anna Hull



Sample size 81-86 cm (32-34")

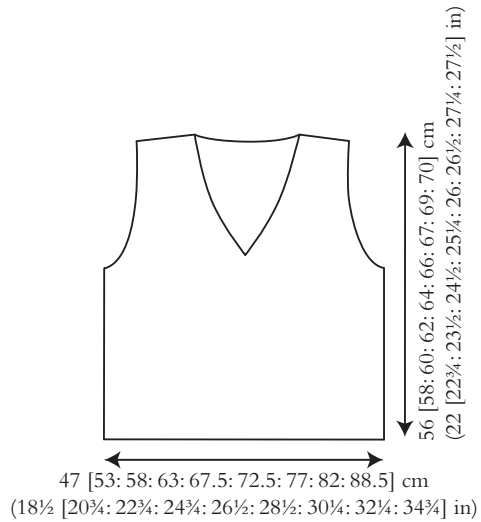

SIZE

To fit chest (cm/in)

71-76 81-86 91-97 102-107 112-117 122-127 132-137 142-147 152-157
28-30 32-34 36-38 40-42 44-46 48-50 52-54 56-58 60-62

Actual chest measurement of garment

93.5 106.5 116 125.5 135 145 154.5 164 177
36¾ 42 45¾ 49½ 53¼ 57 60¾ 64½ 69¾

YARN

Felted Tweed (50gm)

A Treacle 145

3 3 3 4 4 4 5 5 5

B Ginger 154

3 3 3 3 4 4 4 5 5

NEEDLES

1 pair 3¼mm (no 10) (US 3) needles

1 pair 3¾mm (no 9) (US 5) needles

3¾mm (no 10) (US 3) circular needle at least 60 cm long

TENSION

25 sts and 38 rows to 10 cm measured over patt using 3¾mm (US 5) needles.

GREEN LANE

Kaffe Fassett



YARN

Felted Tweed (50gm)

Version 1

A Ultramarine 214	1
B Carbon 159	1
C Clay 177	2

D Ancient 172	2
E Scree 165	1
F Ciel 215	1
G Frozen 185	1
H Pink Bliss 199	1
I Barbara 200	1
J Fjord 218	1
K Watery 152	1
L Scarlet 222	1
M Rage 150	1
N Lime 213	1
O Electric Green 203	1
P Pine 158	1
Q Heliotrope 219	1
R Iris 201	1

Version 2

A Clay 177	2
B Ancient 172	2
C Lime 213	1
D Electric Green 203	1
E Pine 158	1
F Frozen 185	1
G Heliotrope 219	1
H Iris 201	1

NEEDLES

4mm (no 8) (US 6) circular needle no more than 80 cm long

TENSION

26 sts and 26 rounds to 10 cm measured over patterned st st, 22 sts and 30 rounds measured over st st, both using 4mm (US 6) circular needle.

TREGWYNT

Anna Hull



YARN

Alpaca Classic (25gm)

A Foliage Green 110	1
B Copper Clay 119	1
C Green Moss 111	1
D Dahlia 121	1
E Golden Girl 114	1

CROCHET HOOK

3.00mm (no 11) (US C2/D3) crochet hook

TENSION

18½ sts to 16½ rows to 10 cm measured over patt using 3.00mm (US C2/D3) crochet hook.

BROOKES

Lisa Richardson



Sample size 81-86 cm (32-34")

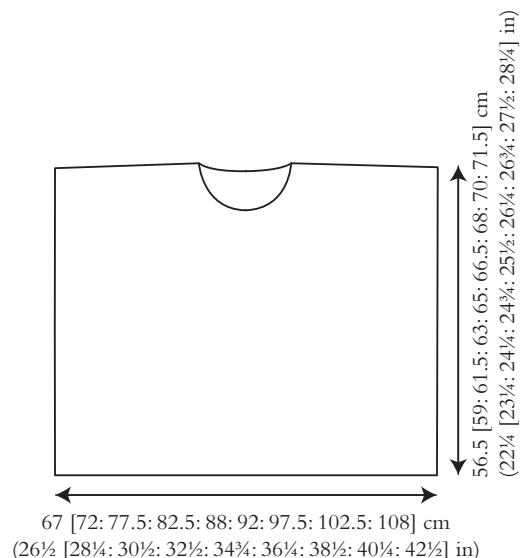
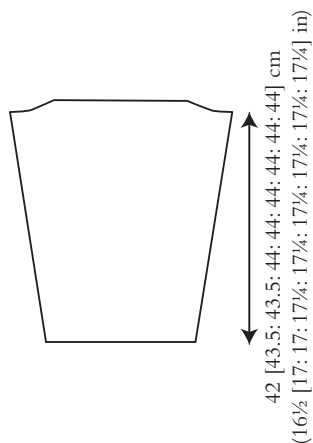

SIZE

To fit chest (cm/in)

71-76 81-86 91-97 102-107 112-117 122-127 132-137 142-147 152-157

28-30 32-34 36-38 40-42 44-46 48-50 52-54 56-58 60-62

Actual chest measurement of garment

134 144.5 155 165 175.5 184.5 195 205 215.5

52¾ 57 61 65 69 72¾ 76¾ 80¾ 84¾

YARN

Felted Tweed and Alpaca Classic (50gm/25gm)

A Felted Tweed Alabaster 197

6 6 7 7 8 8 9 9 10

B Alpaca Classic Copper Clay 119

4 5 5 5 6 6 6 7 7

C Felted Tweed Khaki 228

2 2 2 3 3 3 3 3 3

D Alpaca Classic Foliage Green 110

2 2 2 2 2 3 3 3 3

E Felted Tweed Sulfur 220

1 1 1 1 1 1 1 2 2

NEEDLES

1 pair 3¼mm (no 10) (US 3) needles

1 pair 4mm (no 8) (US 6) needles

TENSION

27 sts and 26 rows to 10 cm measured over patterned st st using 4mm (US 6) needles.

CRAVEN

Lisa Richardson



Sample size 81-86 cm (32-34")



24 [25; 25; 26; 26; 26; 26; 26] cm
(9½ [9¾; 9¾; 10¼; 10¼; 10¼; 10¼; 10¼] in)

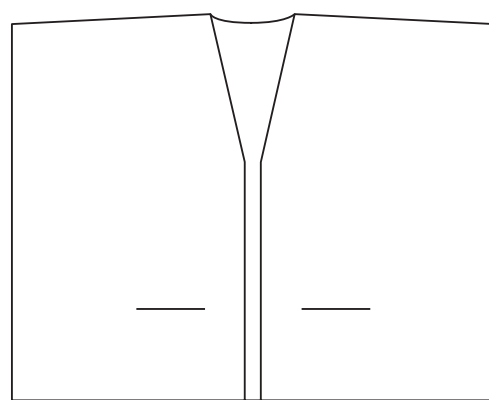

87.5 [91.5; 97; 102; 107.5; 111.5; 117; 122; 128.5] cm
(34½ [36; 38¼; 40¼; 42¼; 44; 46; 48; 50½] in)

71 [73; 75; 77; 79; 81; 82; 84; 85] cm
(28 [28¾; 29¾; 30¾; 31; 32; 32¼; 33; 33½] in)

SIZE

To fit chest (cm/in)

71-76 81-86 91-97 102-107 112-117 122-127 132-137 142-147 152-157

28-30 32-34 36-38 40-42 44-46 48-50 52-54 56-58 60-62

Actual chest measurement of garment

175 183.5 194 204.5 215 223.5 234 244.5 256.5

69 72¼ 76½ 80½ 84¾ 88 92¼ 96¼ 101

YARN

Alpaca Classic (25gm)

14 15 16 18 19 20 21 23 24

(photographed in Toffee 135)

NEEDLES

1 pair 3¼mm (no 10) (US 3) needles

1 pair 3¾mm (no 9) (US 5) needles

3¾mm (no 10) (US 3) circular needle at least 120 cm long

For sizes 102-107, 112-117, 122-127, 132-137, 142-147 and 152-157 cm, you may prefer to use a circular needle for the back, working backwards and forwards in rows.

BUTTONS – 5 x TGB3020 (grey shank 15mm) from Textile Garden. Please see information page for contact details.

TENSION

23 sts and 31 rows to 10 cm measured over patt using 3¾mm (US 5) needles.

DALTON

Annika Andrea Wölke



Sample size 81-86 cm (32-34")

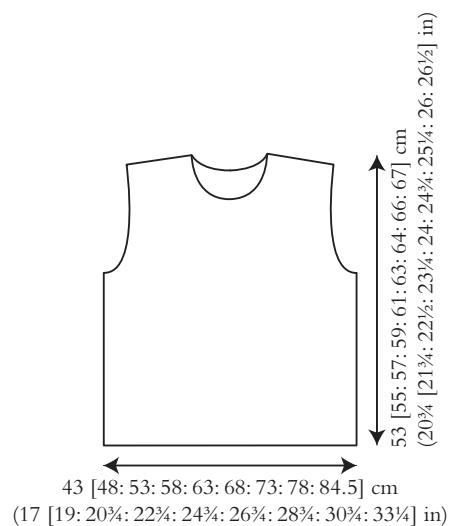
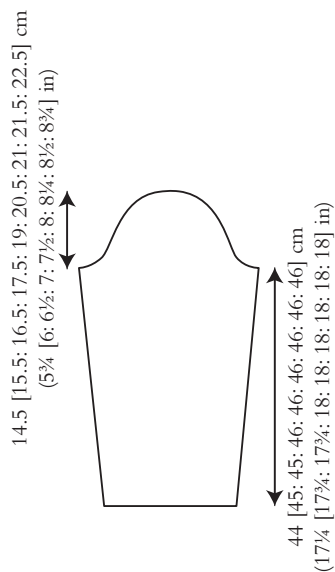

SIZE

To fit chest (cm/in)

71-76 81-86 91-97 102-107 112-117 122-127 132-137 142-147 152-157
28-30 32-34 36-38 40-42 44-46 48-50 52-54 56-58 60-62

Actual chest measurement of garment

86 96 106 116 126 136 146 156 169
33¾ 37¾ 41¾ 45¾ 49½ 53½ 57½ 61½ 66½

YARN

Felted Tweed (50gm) and **Alpaca Classic** (25gm)

A Felted Tweed Lotus Leaf 205

5 5 6 6 7 8 8 8 9

B Alpaca Classic Golden Girl 114

1 1 1 1 2 2 2 2 2

C Alpaca Classic Green Moss 111

1 1 1 1 1 1 1 1 1

D Alpaca Classic Toffee 13

1 1 1 1 1 2 2 2 2

E Alpaca Classic Foliage Green 110

1 1 1 1 1 1 1 1 1

NEEDLES

1 pair 3½mm (no 10/9) (US 4) needles

1 pair 4mm (no 8) (US 6) needles

3½mm (no 10/9) (US 4) circular needle no more than 30 cm long (or set of double-pointed needles if preferred)

TENSION

22 sts and 30 rows to 10 cm measured over st st using yarn A and 4mm

(US 6) needles. 24 sts and 40 rows to 10 cm measured over body patt using

4mm (US 6) needles.

DIGLEY

Galina Carroll



Sample size 81-86 cm (32-34")

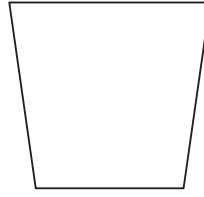

34.5 [35; 35; 36; 36; 36; 36] cm
(13½ [13¾; 13¾; 14¼; 14¼; 14¼; 14¼] in)

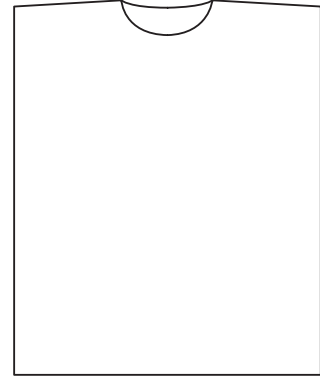

69 [71; 73; 75; 77; 79; 80; 82; 83] cm
(27¼ [28; 28¾; 29½; 30¾; 31; 31½; 32¼; 32¾] in)

52.5 [58; 63.5; 69; 73.5; 79; 83.5; 89; 93.5] cm
20¾ [22¼; 25; 27¼; 29; 31; 32¾; 35; 36¾] in

SIZE

To fit chest (cm/in)

71-76 81-86 91-97 102-107 112-117 122-127 132-137 142-147 152-157

28-30 32-34 36-38 40-42 44-46 48-50 52-54 56-58 60-62

Actual chest measurement of garment

105.5 116 127 137.5 147 157.5 167 177.5 187

41½ 45¾ 50 54¾ 57¾ 62 65¾ 70 73½

YARN

Alpaca Classic (25gm)

A Green Moss 111

7 7 8 9 10 10 11 12 12

B Purple Rain 123

2 3 3 3 3 4 4 4 4

C Foliage Green 110

2 2 2 3 3 3 3 3 4

NEEDLES

1 pair 3¼mm (no 10) (US 3) needles

1 pair 3¾mm (no 9) (US 5) needles

TENSION

26 sts and 27 rows to 10 cm measured over patterned st st using 3¾mm (US 5) needles.

ELLERBY

Florence Spurling



Sample size 81-86 cm (32-34")

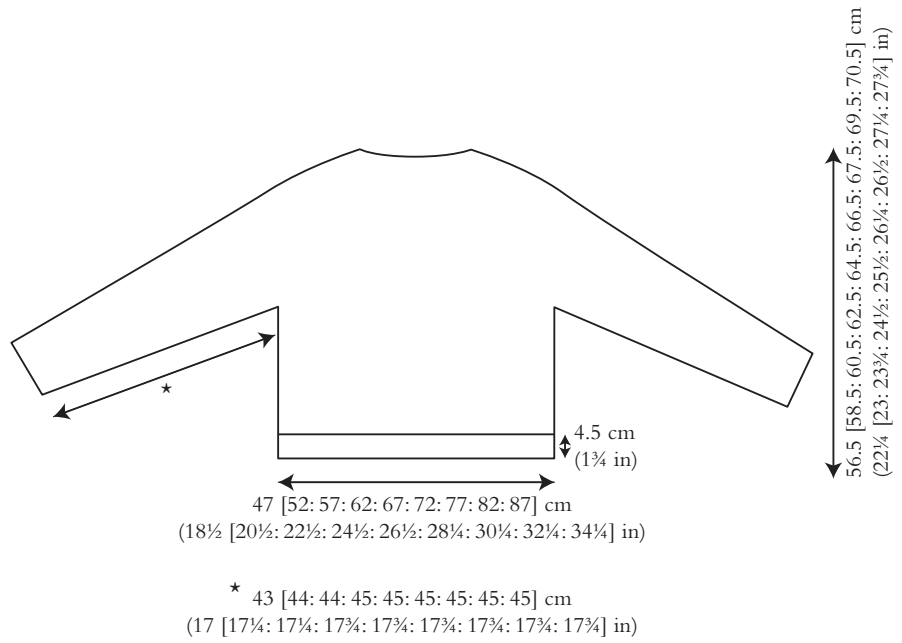

SIZE

To fit chest (cm/in)

71-76 81-86 91-97 102-107 112-117 122-127 132-137 142-147 152-157

28-30 32-34 36-38 40-42 44-46 48-50 52-54 56-58 60-62

Actual chest measurement of garment

94 104 114 124 134 144 154 164 174

37 41 45 48¾ 52¾ 56¾ 60¾ 64½ 68½

YARN

Alpaca Soft DK (50gm)

A Rainy Day 210

8 9 9 11 11 12 13 14 15

B Charcoal 211

2 2 2 2 2 2 3 3 3

NEEDLES

1 pair 3¾mm (no 9) (US 5) needles

Set of 4 double-pointed 3¾mm (no 9) (US 5) needles

Set of 4 double-pointed 4½mm (no 7) (US 7) needles

3¾mm (no 9) (US 5) circular needle no more than 60 [60: 60: 80: 80: 80:

80: 80: 80] cm long

4½mm (no 7) (US 7) circular needle no more than 60 [60: 60: 80: 80: 80:

80: 80: 80] cm long

ELMWOOD

Georgia Farrell



Sample size 81-86 cm (32-34")

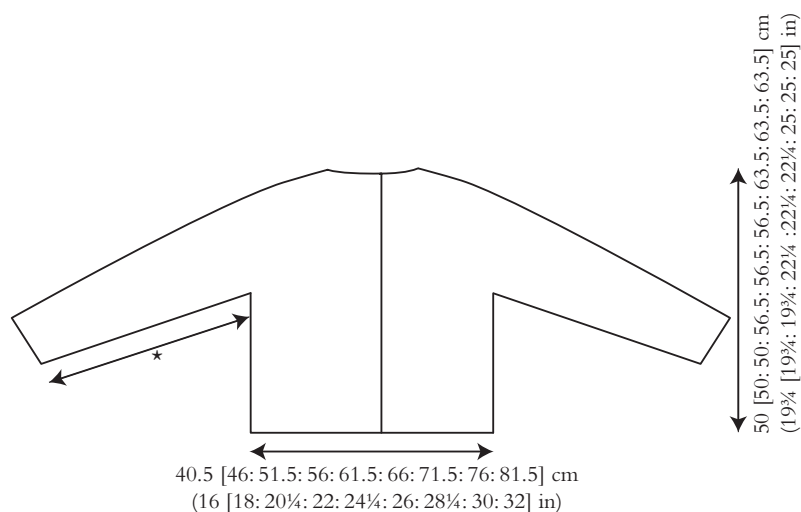

SIZE

To fit chest (cm/in)

71-76	81-86	91-97	102-107	112-117	122-127	132-137	142-147	152-157
28-30	32-34	36-38	40-42	44-46	48-50	52-54	56-58	60-62

Actual chest measurement of garment

81	92	102.5	112	122.5	132	142.5	152	162.5
32	36¼	40¼	44	48¼	52	56	59¾	64

YARN

Felted Tweed (50gm)

A Carbon 159

2	2	3	3	3	3	4	4	4
---	---	---	---	---	---	---	---	---

B French Mustard 216

1	2	2	2	2	2	2	2	2
---	---	---	---	---	---	---	---	---

C Alabaster 197

1	1	1	1	1	2	2	2	2
---	---	---	---	---	---	---	---	---

D Avocado 161

1	1	1	2	2	2	2	2	2
---	---	---	---	---	---	---	---	---

E Granite 191

1	1	1	2	2	2	2	2	2
---	---	---	---	---	---	---	---	---

F Lotus Leaf 205

1	1	1	2	2	2	2	2	2
---	---	---	---	---	---	---	---	---

NEEDLES

1 pair 4mm (no 8) (US 6) needles

4mm (no 8) (US 6) circular needle at least 100 cm long

Set of 4 double-pointed 3½mm (no 10/9) (US 4) needles

Set of 4 double-pointed 4mm (no 8) (US 6) needles

BUTTONS - 8 [8: 8: 9: 9: 9: 10: 10: 10] x TGB4276 (mussel shell 15mm) from Textile Garden. Please see information page for contact details.

TENSION

22 sts and 30 rows to 10 cm measured over st st using 4mm (US 6) needles.

GLOBE

Lisa Richardson



Sample size 81-86 cm (32-34")

13.5 [14.5; 15.5; 16.5; 18; 18.5; 19.5; 20; 20.5] cm
(5¼ [5½; 6; 6½; 7; 7¼; 7½; 8] in)

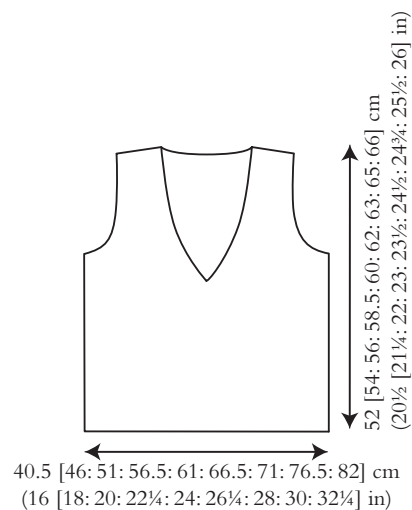
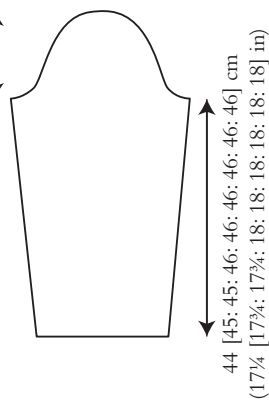

SIZE

To fit chest (cm/in)

71-76 81-86 91-97 102-107 112-117 122-127 132-137 142-147 152-157
28-30 32-34 36-38 40-42 44-46 48-50 52-54 56-58 60-62

Actual chest measurement of garment

81	91.5	102.5	113	122.5	133	142.5	153	164
32	36	40¼	44½	48¼	52¼	56	60¼	64½

YARN

Felted Tweed (50gm)

A Cumin 193

3	3	3	4	4	4	4	5	5
---	---	---	---	---	---	---	---	---

B Mint 226

2	2	2	3	3	3	3	3	3
---	---	---	---	---	---	---	---	---

C Barn Red 196

2	2	2	2	3	3	3	3	3
---	---	---	---	---	---	---	---	---

D Alabaster 197

1	1	1	1	1	1	1	1	1
---	---	---	---	---	---	---	---	---

E Watery 152

1	1	1	1	1	1	1	1	1
---	---	---	---	---	---	---	---	---

NEEDLES

1 pair 3¼mm (no 10) (US 3) needles

1 pair 4mm (no 8) (US 6) needles

TENSION

26 sts and 26 rows to 10 cm measured over patterned st st, 22 sts and 30 rows to 10 cm measured over st st, both using 4mm (US 6) needles.

HARCOURT

Vibe Ulrik



Sample size 81-86 cm (32-34")

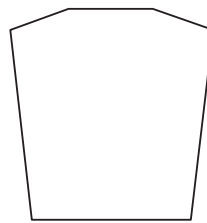

35 [36: 36: 37: 37: 37: 37] cm
(13½ [14½: 14½: 14½: 14½: 14½: 14½: 14½] in)

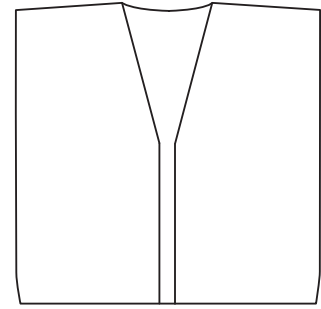

54.5 [57: 58.5: 61: 63: 66: 68: 68.5] cm
(21½ [22½: 23: 24: 24¾: 25½: 26: 26¾: 27] in)

52 [57.5: 62.5: 68: 73: 78.5: 83.5: 88.5: 94] cm
(20½ [22¾: 24½: 26¾: 28¾: 31: 32¾: 34¾: 37] in)

SIZE

To fit chest (cm/in)

71-76 81-86 91-97 102-107 112-117 122-127 132-137 142-147 152-157

28-30 32-34 36-38 40-42 44-46 48-50 52-54 56-58 60-62

Actual chest measurement of garment

104.5 115 125 135.5 146 156.5 167 177.5 188

41¼ 45¼ 49¼ 53¼ 57½ 61½ 65¾ 70 74

YARN

Felted Tweed (50gm)

7 7 8 9 10 11 11 12 13

(photographed in Sorbet 227)

NEEDLES

1 pair 3¼mm (no 10) (US 3) needles

1 pair 3¾mm (no 9) (US 5) needles

3¼mm (no 10) (US 3) circular needle at least 120 cm long

3¾mm (no 9) (US 5) circular needle at least 120 cm long

TENSION

23 sts and 32 rows to 10 cm measured over patt using 3¾mm (US 5) needles.

HIGHFIELD

Martin Storey



Sample size 81-86 cm (32-34")

14 [15: 16.5: 17.5: 19: 20: 20.5: 21.5: 22] cm
(5½ [6: 6½: 7: 7½: 8: 8½: 8¾] in)

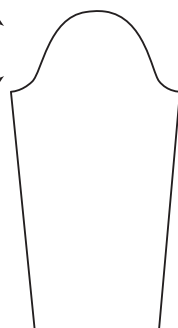

44 [45: 45: 46: 46: 46: 46: 46] cm
(17¼ [17¼: 17¼: 18: 18: 18: 18: 18] in)

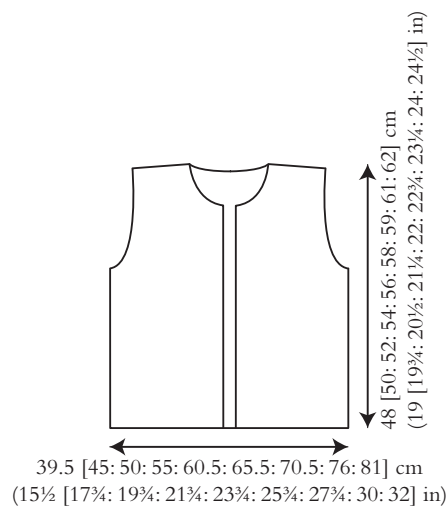

39.5 [45: 50: 55: 60.5: 65.5: 70.5: 76: 81] cm
(15½ [17¼: 19¼: 21¼: 23¼: 25¼: 27¼: 30: 32] in)

SIZE

To fit chest (cm/in)

71-76	81-86	91-97	102-107	112-117	122-127	132-137	142-147	152-157
28-30	32-34	36-38	40-42	44-46	48-50	52-54	56-58	60-62

Actual chest measurement of garment

79.5	89.5	100	110.5	120.5	131	141.5	152	162
31¼	35¼	39¼	43½	47½	51½	55¾	59¾	63¾

YARN

Alpaca Soft DK (50gm)

9	10	11	13	14	15	16	17	18
---	----	----	----	----	----	----	----	----

(photographed in Autumn Gold 220)

NEEDLES

1 pair 3¼mm (no 10) (US 3) needles

1 pair 4mm (no 8) (US 6) needles

Cable needle

BUTTONS – 7 x TGB2869 (grey corozo 18mm) from Textile Garden.

Please see information page for contact details.

TENSION

27 sts and 32 rows to 10 cm measured over patt using 4mm (US 6) needles.

GUISELEY

Anna Hull



Sample size 81-86 cm (32-34")

13 [14: 15: 16.5: 17: 18.5: 19: 19.5: 19.5] cm
(5 [5½: 6: 6½: 7¼: 7¾: 7¾] in)

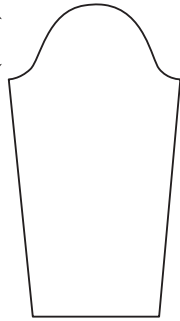

44 [45: 45: 46: 46: 46: 46: 46] cm
(17¼ [17¼: 17¾: 18: 18: 18: 18: 18] in)

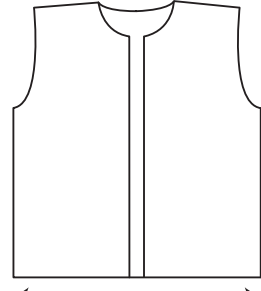

50 [52: 54: 56: 58: 60.5: 61.5: 63: 64] cm
(19¾ [20½: 21¼: 22: 22¾: 23¾: 24¼: 24¾: 25¼] in)

41.5 [46.5: 51.5: 57: 62: 67.5: 72.5: 78: 83] cm
(16¼ [18¼: 20¼: 22½: 24½: 26½: 28½: 30¾: 32¾] in)

SIZE

To fit chest (cm/in)

71-76 81-86 91-97 102-107 112-117 122-127 132-137 142-147 152-157

28-30 32-34 36-38 40-42 44-46 48-50 52-54 56-58 60-62

Actual chest measurement of garment

82.5 93 103.5 114 124.5 135 145 155.5 166

32½ 36½ 40¾ 45 49 53¼ 57 61¼ 65¼

YARN

Alpaca Classic (25gm)

A Deep Teal 109

7 8 8 9 10 11 12 13 13

B Green Moss 111

1 1 1 1 1 1 1 2 2

C Toffee 13

1 1 1 1 1 1 1 1 1

NEEDLES

1 pair 3¼mm (no 10) (US 3) needles

1 pair 3¾mm (no 9) (US 5) needles

BUTTONS – 7 x TGB4083 (wooden 15mm) from Textile Garden. Please see information page for contact details.

TENSION

23 sts and 31 rows to 10 cm measured over st st, 26 sts and 28 rows to 10 cm measured over patterned st st, both using 3¾mm (US 5) needles.

MOORBROOK

ARNE & CARLOS



YARN

Felted Tweed (50gm)

A Fjord 218	1
B Black 211	1
C Duck Egg 173	1
D Stone 190	1
E Peach 212	1
F Alabaster 197	1
G Celadon 184	1
H Pine 158	1

NEEDLES

Set of 4 double-pointed 3¼mm (no 10) (US 3) needles

Set of 4 double-pointed 3¼mm (no 9) (US 5) needles

TENSION

26 sts and 27 rounds to 10 cm measured over patterned st st using 3¼mm (US 5) needles.

FINISHED SIZE

Completed hat is 46 cm (18 in) in circumference and 25 cm (9¾ in) deep.

HINCHLIFFE

Lisa Richardson



Sample size 81-86 cm (32-34")

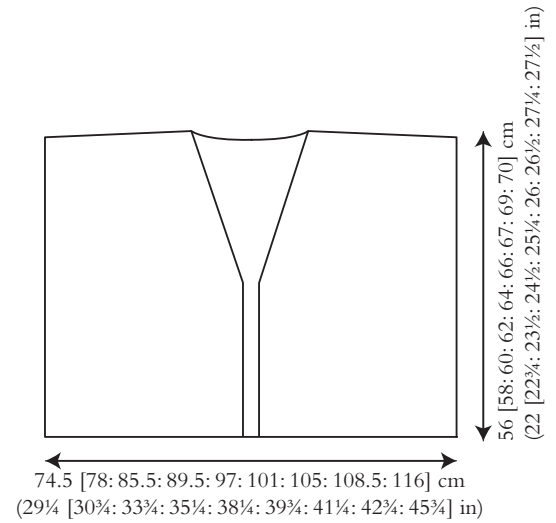
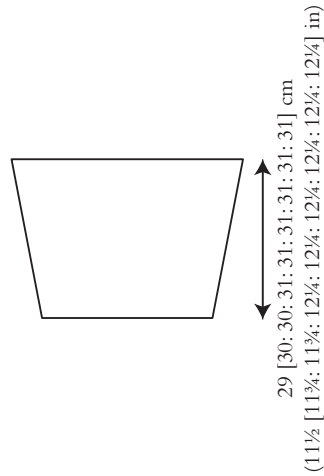

SIZE

To fit chest (cm/in)

71-76	81-86	91-97	102-107	112-117	122-127	132-137	142-147	152-157
28-30	32-34	36-38	40-42	44-46	48-50	52-54	56-58	60-62
Actual chest measurement of garment								
148.5	156	171.5	179	194.5	202	209.5	217	232.5
58½	61½	67½	70½	76½	79½	82½	85½	91½

YARN

Alpaca Soft DK (50gm)

15	16	18	19	21	22	23	25	26
----	----	----	----	----	----	----	----	----

(photographed in Clover 215)

NEEDLES

1 pair 3¼mm (no 10) (US 3) needles

1 pair 4mm (no 8) (US 6) needles

3¼mm (no 10) (US 3) circular needle at least 120 cm long

Cable needle

For sizes 122-127, 132-137, 142-147 and 152-157 cm, you may prefer to use a circular needle for the back, working backwards and forwards in rows.

BUTTONS – 4 x TGB4837 (brown corozo 23mm) from Textile Garden. Please see information page for contact details.

TENSION

21 sts to 10 cm measured over g st using 4mm (US 6) needles. Wide cable panel (40 sts) meas 12.75 cm, and narrow cable panel (12 sts) meas 4.25 cm. Over combination of cables and g st, row tension is 34 rows to 10 cm.

HUNSLET

Martin Storey



Sample size 81-86 cm (32-34")

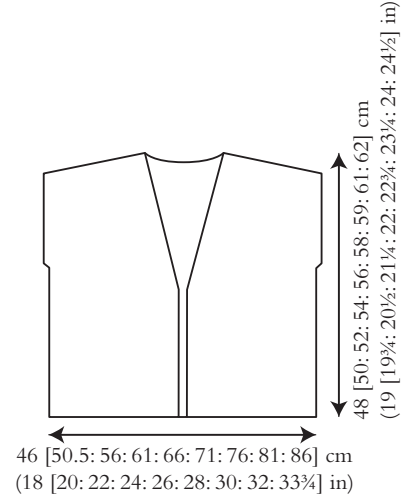
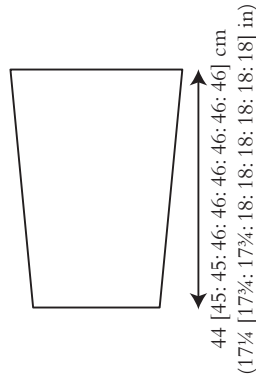

SIZE

To fit chest (cm/in)

71-76 81-86 91-97 102-107 112-117 122-127 132-137 142-147 152-157

28-30 32-34 36-38 40-42 44-46 48-50 52-54 56-58 60-62

Actual chest measurement of garment

91.5 101 111.5 122.5 131.5 142.5 151.5 162.5 171.5

36 39¾ 44 48¾ 51¾ 56 59¾ 64 67½

YARN

Felted Tweed (50gm)

A Seafarer 170

4 5 5 6 6 7 7 8 8

B Camel 157

3 3 3 4 4 4 5 5 5

NEEDLES

1 pair 3¼mm (no 10) (US 3) needles

1 pair 3¾mm (no 9) (US 5) needles

3¼mm (no 10) (US 3) circular needle at least 100 cm long

BUTTONS – 3 x TGB4777 (imitation horn 25mm) from Textile Garden.

Please see information page for contact details.

TENSION

26 sts and 27 rows to 10 cm measured over patterned st st using 3¾mm (US 5) needles.

L I S T E R

Brandon Mably



Sample size 81-86 cm (32-34")

13 [13.5; 15; 16.5; 17; 18.5; 19; 19.5; 20.5] cm
(5 [5½; 6; 6½; 6¾; 7½; 7¾; 8] in)



44 [45; 45; 46; 46; 46; 46; 46] cm
(17¼ [17¼; 17¾; 18; 18; 18; 18; 18] in)

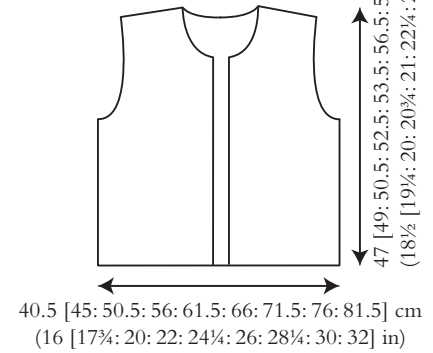

47 [49; 50.5; 52.5; 53.5; 56.5; 57; 59.5; 60.5] cm
(18½ [19¼; 20; 20¾; 21; 22¼; 22¾; 23½; 23¾] in)

40.5 [45; 50.5; 56; 61.5; 66; 71.5; 76; 81.5] cm
(16 [17¼; 20; 22; 24¼; 26; 28¼; 30; 32] in)

SIZE

To fit chest (cm/in)

71-76 81-86 91-97 102-107 112-117 122-127 132-137 142-147 152-157
28-30 32-34 36-38 40-42 44-46 48-50 52-54 56-58 60-62

Actual chest measurement of garment

81	90	101	112	122.5	132	142.5	152	162.5
32	35½	39¾	44	48¼	52	56	59¾	64

YARN

Felted Tweed (50gm)

A Maritime 167

2	2	2	2	2	2	3	3	3
---	---	---	---	---	---	---	---	---

B Seasalter 178

2	2	2	2	2	2	2	2	2
---	---	---	---	---	---	---	---	---

C Lime 213

1	1	2	2	2	2	2	2	2
---	---	---	---	---	---	---	---	---

D French Mustard 216

1	1	1	1	1	1	1	2	2
---	---	---	---	---	---	---	---	---

E Ciel 215

1	1	1	1	1	1	1	1	1
---	---	---	---	---	---	---	---	---

F Peach 212

1	1	1	1	1	1	1	2	2
---	---	---	---	---	---	---	---	---

G Scarlet 222

1	1	1	1	1	1	1	1	1
---	---	---	---	---	---	---	---	---

H Camel 157

1	1	1	1	1	1	2	2	2
---	---	---	---	---	---	---	---	---

NEEDLES

1 pair 3¼mm (no 10) (US 3) needles

1 pair 4mm (no 8) (US 6) needles

BUTTONS – 5 x TGB1167 (brass 12mm) from Textile Garden. Please see information page for contact details.

TENSION

22 sts and 30 rows to 10 cm measured over st st using 4mm (US 6) needles.

MARSHALL

Chloe Thurlow



Sample size 81-86 cm (32-34")

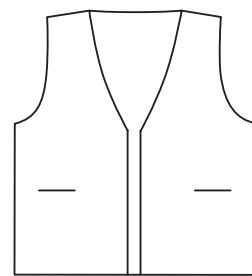

48 [50: 52: 54: 56: 58: 59: 61: 62] cm
 (19 [19¾: 20½: 21¼: 22: 22¾: 23¼: 24: 24½] in)

40 [45.5: 50: 55.5: 60: 65.5: 70: 75.5: 81] cm
 (15¾ [18: 19¾: 21¼: 23½: 25¼: 27½: 29¼: 32] in)

SIZE

To fit chest (cm/in)

71-76 81-86 91-97 102-107 112-117 122-127 132-137 142-147 152-157

28-30 32-34 36-38 40-42 44-46 48-50 52-54 56-58 60-62

Actual chest measurement of garment

80	91	100	111	120	131	140	151	161.5
31½	35¾	39¾	43¾	47¼	51½	55	59½	63½

YARN

Felted Tweed (50gm)

A Stone 190

2	3	3	3	4	4	4	4	5
---	---	---	---	---	---	---	---	---

B Amethyst 192

2	2	2	2	2	3	3	3	3
---	---	---	---	---	---	---	---	---

C Seafarer 170

1	1	1	1	1	1	1	1	1
---	---	---	---	---	---	---	---	---

NEEDLES

1 pair 3¾mm (no 10) (US 3) needles

1 pair 3¾mm (no 9) (US 5) needles

3¾mm (no 10) (US 3) circular needle at least 120 cm long

BUTTONS – 5 x TGB4276 (mussel shell 15mm) from Textile Garden.

Please see information page for contact details.

TENSION

26 sts and 27 rows to 10 cm measured over patterned st st using 3¾mm (US 5) needles.

MEIRION

Anna Hull



Sample size 81-86 cm (32-34")

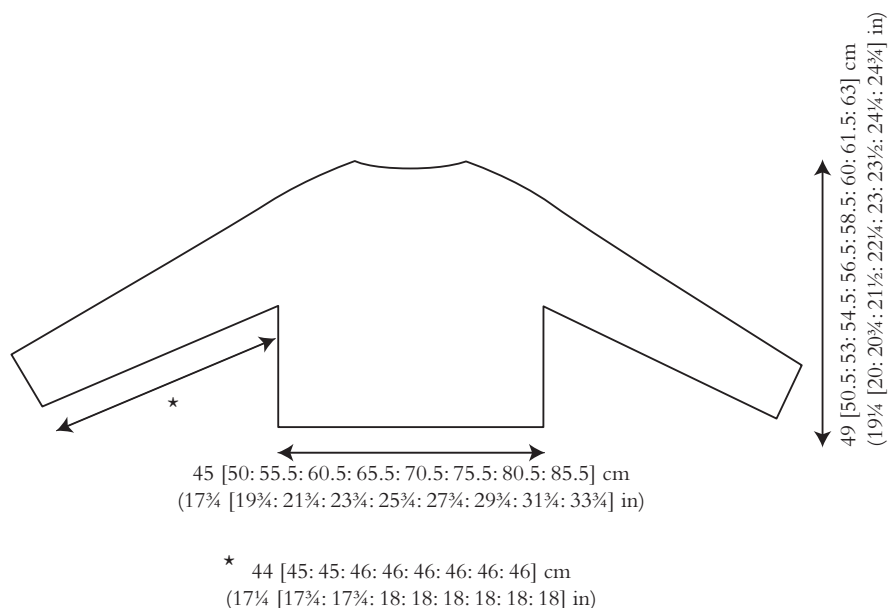

SIZE

To fit chest (cm/in)

71-76 81-86 91-97 102-107 112-117 122-127 132-137 142-147 152-157

28-30 32-34 36-38 40-42 44-46 48-50 52-54 56-58 60-62

Actual chest measurement of garment

90	100	111	121	131	141	151	161	171
35½	39¼	43¾	47¾	51½	55½	59½	63½	67¼

YARN

Felted Tweed (50gm)

A Scree 165

6 6 7 8 8 9 9 10 11

B Barn Red 196

1 1 1 1 1 1 1 1 1

NEEDLES

Set of 4 double-pointed 3¼mm (no 10) (US 3) needles

Set of 4 double-pointed 3¼mm (no 9) (US 5) needles

3¼mm (no 10) (US 3) circular needle no more than 60 [60: 60: 80: 80: 80: 80: 80: 80] cm long

3¼mm (no 9) (US 5) circular needle no more than 60 [60: 60: 80: 80: 80: 80: 80: 80] cm long

TENSION

24 sts and 32 rounds to 10 cm measured over st st, 25 sts and 28 rounds to

10 cm measured over patterned st st, both using 3¼mm (US 5) needles.

POTTERDALE

Quail Studio



Sample size 81-86 cm (32-34")

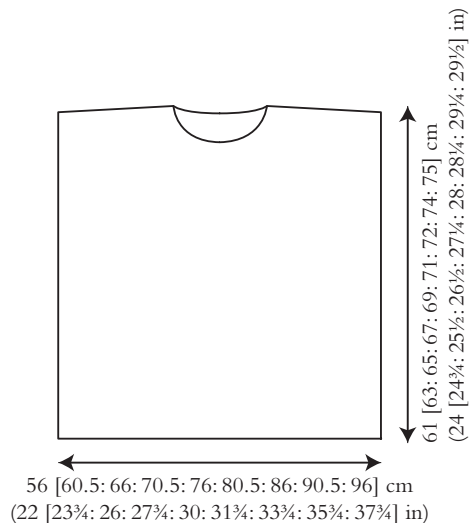
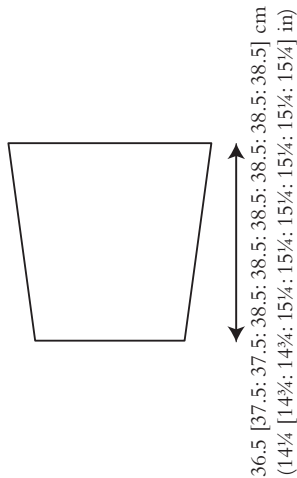

SIZE

To fit chest (cm/in)

71-76	81-86	91-97	102-107	112-117	122-127	132-137	142-147	152-157
28-30	32-34	36-38	40-42	44-46	48-50	52-54	56-58	60-62
Actual chest measurement of garment								
111.5	121	131.5	141	151.5	161	171.5	181	191.5
44	47 $\frac{3}{4}$	51 $\frac{3}{4}$	55 $\frac{1}{2}$	59 $\frac{3}{4}$	63 $\frac{1}{2}$	67 $\frac{1}{2}$	71 $\frac{1}{4}$	75 $\frac{1}{2}$

YARN

Felted Tweed (50gm)

A Carbon 159	5	5	6	6	7	7	8	8	9
B Clay 177	3	3	3	3	4	4	4	4	5
C Granite 191	1	1	1	1	1	1	1	2	2
D Mint 226	1	2	2	2	2	2	2	2	2

NEEDLES

Set of 4 double-pointed 3 $\frac{3}{4}$ mm (no 10) (US 3) needles
 Set of 4 double-pointed 3 $\frac{3}{4}$ mm (no 9) (US 5) needles
 3 $\frac{3}{4}$ mm (no 10) (US 3) circular needle no more than 60 [60: 60: 80: 80: 80: 80: 80: 80] cm long
 3 $\frac{3}{4}$ mm (no 9) (US 5) circular needle no more than 60 [60: 60: 80: 80: 80: 80: 80: 80] cm long

TENSION

24 sts and 32 rounds to 10 cm measured over st st, 25 sts and 28 rounds to 10 cm measured over patterned st st, both using 3 $\frac{3}{4}$ mm (US 5) needles.

ROSS

Lisa Richardson



Sample size 81-86 cm (32-34")

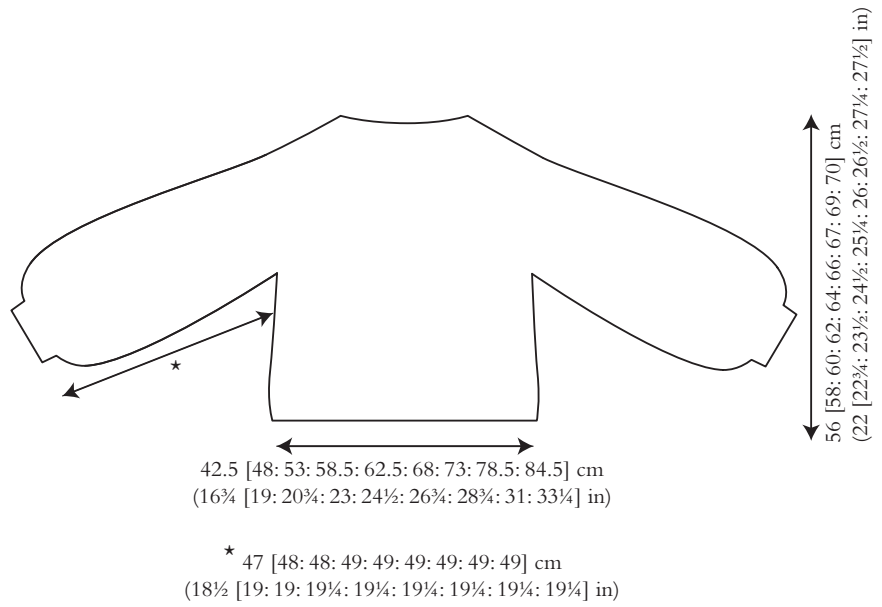

SIZE

To fit chest (cm/in)

71-76 81-86 91-97 102-107 112-117 122-127 132-137 142-147 152-157

28-30 32-34 36-38 40-42 44-46 48-50 52-54 56-58 60-62

Actual chest measurement of garment

85 95.5 106 116.5 125 135.5 146 156.5 168.5

33½ 37½ 41¾ 45¾ 49¼ 53¼ 57½ 61½ 66¼

YARN

Alpaca Classic (25gm)

11 11 12 13 15 16 16 17 18

(photographed in Elephant Grey Melange 132)

NEEDLES

3¼mm (no 10) (US 3) circular needles – one no more than 40 cm long and

second no more than 80 [90: 100: 110: 120: 130: 140: 150] cm long

3¾mm (no 9) (US 5) circular needles – one no more than 40 cm long and

second no more than 80 [90: 100: 110: 120: 130: 140: 150] cm long

Set of 4 double-pointed 3¼mm (no 10) (US 3) needles

Cable needle

TENSION

23 sts and 31 rows to 10 cm measured over rev st st using 3¾mm (US 5) needles.

SALTS

Erika Knight



Sample size 81-86 cm (32-34")

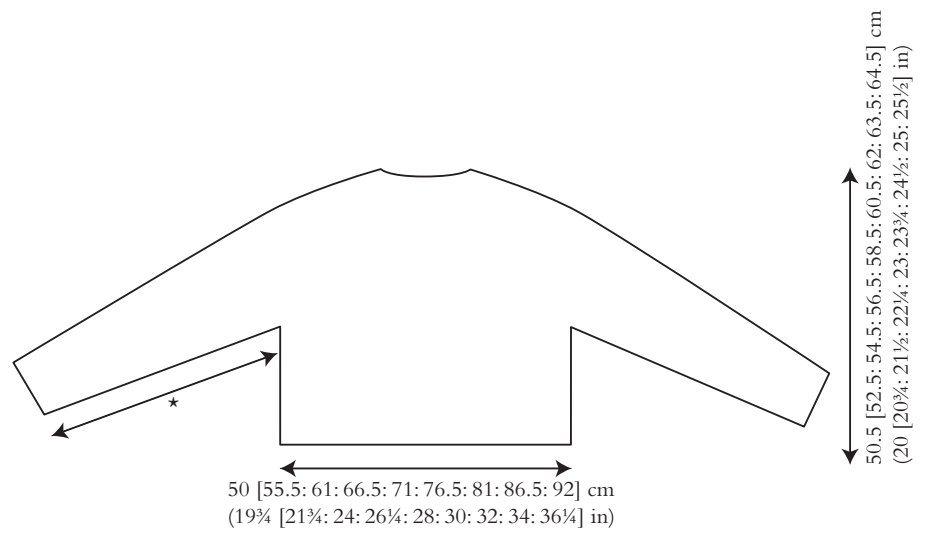

SIZE

To fit chest (cm/in)

71-76 81-86 91-97 102-107 112-117 122-127 132-137 142-147 152-157

28-30 32-34 36-38 40-42 44-46 48-50 52-54 56-58 60-62

Actual chest measurement of garment

100 111 122 132.5 142 152.5 162 172.5 183.5

39 1/4 43 3/4 48 52 1/4 56 60 63 3/4 68 72 1/4

YARN

Felted Tweed (50gm)

A Camel 157

1 1 1 1 2 2 2 2 2

B Stone 190

2 2 2 2 2 3 3 3 3

C Rage 150

1 1 1 1 1 1 1 1 1

D Watery 152

1 1 1 1 1 1 2 2 2

E Peach 212

1 1 1 1 1 1 1 1 1

F Ginger 154

1 1 1 1 1 1 1 1 1

G Phantom 153

1 1 1 1 1 1 1 1 2

H French Mustard 216

1 1 1 1 1 1 1 1 1

I Amethyst 192

1 1 1 1 1 1 1 1 1

J Aluminium 210

1 1 1 1 1 1 1 1 1

NEEDLES

Set of 4 double-pointed 3 3/4mm (no 9) (US 5) needles

Set of 4 double-pointed 4mm (no 8) (US 6) needles

4mm (no 8) (US 6) circular needle no more than 60 [60: 60: 80: 80: 80: 80:

80: 80] cm long

TENSION

22 sts and 30 rows to 10 cm measured over st st using 4mm (US 6) needles.

SUNNY BANK

Lisa Richardson



Sample size 71-86 cm (28-34")

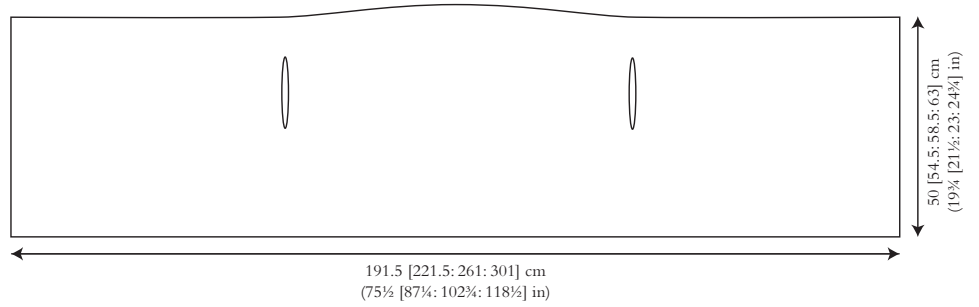

SIZE

To fit chest (cm/in)

71-86	91-107	112-132	137-157
28-34	36-42	44-52	54-62

YARN

Alpaca Classic (25gm)

A Green Moss 111

2	3	4	4
---	---	---	---

B Dahlia 121

2	3	4	4
---	---	---	---

C Champagne 127

4	5	6	8
---	---	---	---

D Golden Girl 114

2	3	4	4
---	---	---	---

E Vermillion 120

2	3	4	4
---	---	---	---

NEEDLES

1 pair 3¼mm (no 10) (US 3) needles

1 pair 3¾mm (no 9) (US 5) needles

TENSION

23 sts and 31 rows to 10 cm measured over rev st st using 3¾mm (US 5) needles.

STYAL

Anna Hull



Sample size 81-86 cm (32-34")

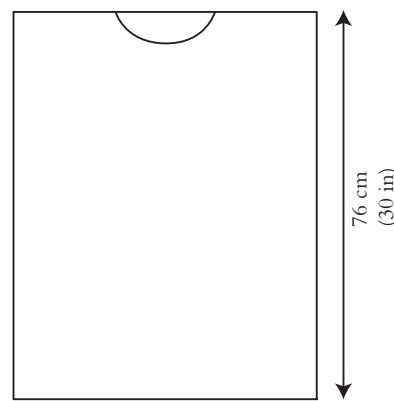
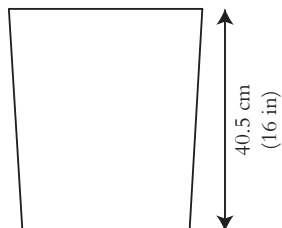

53.5 [57.5: 63.5: 67.5: 73.5: 77.5: 83.5: 87.5: 93.5] cm
(21 [22¼: 25: 26½: 29: 30½: 32¾: 34½: 36¾] in)

SIZE

To fit chest (cm/in)

71-76 81-86 91-97 102-107 112-117 122-127 132-137 142-147 152-157
28-30 32-34 36-38 40-42 44-46 48-50 52-54 56-58 60-62

Actual chest measurement of garment

107 115 127 135 147 155 167 175 187
42¼ 45¼ 50 53¼ 57¾ 61 65¾ 69 73½

YARN

Alpaca Classic (25gm)

16 17 19 20 21 22 24 25 27

(photographed in Silver 134)

CROCHET HOOK

3.00mm (no 11) (US C2/D3) crochet hook

TENSION

26 sts and 23 rows to 10 cm over hem and cuff border patt, and neckband, using 3.00mm (US C2/D3) crochet hook. 20 sts to 10 cm measured over all other patts using 3.00mm (US C2/D3) crochet hook. 16 rows to **11** cm over bobble patt, 16 rows to **14** cm over waffle patt, 10 rows to **8** cm over stairs patt, and 16 rows to 10 cm over diamond patt. Each lace stripe (3 rows) meas 1.5 cm.

SPRINGFIELD

Chloe Thurlow



Sample size 81-86 cm (32-24")

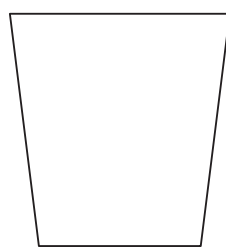

43 [44: 44: 45: 45: 45: 45: 45] cm
(17 [17¼: 17¼: 17¾: 17¾: 17¾: 17¾: 17¾] in)

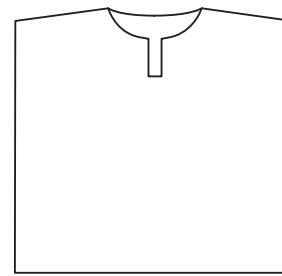

48 [50: 52: 54: 56: 58: 59: 61: 62] cm
(19 [19½: 20½: 21¼: 22: 22¾: 23¾: 24: 24½] in)

47.5 [52.5: 57.5: 62.5: 67.5: 72.5: 77.5: 82.5: 88.5] cm
(18¾ [20¾: 22¾: 24½: 26½: 28½: 30½: 32½: 34¾] in)

SIZE

To fit chest (cm/in)

71-76	81-86	91-97	102-107	112-117	122-127	132-137	142-147	152-157
28-30	32-34	36-38	40-42	44-46	48-50	52-54	56-58	60-62

Actual chest measurement of garment

95	105	115	125	135	145	155	165	176.5
37½	41¼	45¾	49¾	53¾	57	61	65	69½

YARN

Alpaca Soft DK (50gm)

9	10	11	12	13	13	14	15	16
---	----	----	----	----	----	----	----	----

(photographed in Trench Coat 202)

NEEDLES

1 pair 3¼mm (no 10) (US 3) needles

1 pair 4mm (no 8) (US 6) needles

Cable needle

BUTTONS – 3 x TGB2869 (grey corozo with laser fl wer 18mm) from Textile Garden. Please see information page for contact details.

TENSION

24 sts and 30 rows to 10 cm measured over patt using 4mm (US 6) needles.

TREFRIW

Lisa Richardson



Sample size 81-86 cm (32-34")

13 [14: 15: 16: 17.5: 18.5: 19: 19.5: 20.5] cm
(5 [5½: 6: 6¼: 7: 7¼: 7½: 7¾: 8] in)



44 [45: 45: 46: 46: 46: 46: 46] cm
(17¼ [17¼: 17¼: 18: 18: 18: 18: 18] in)

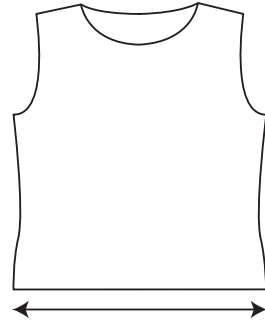

40.5 [45: 51: 55.5: 60.5: 66: 71: 75.5: 81] cm
(16 [17¼: 20: 21¼: 23¾: 26: 28: 29¾: 32] in)

52 [54: 56: 58: 60: 62: 63: 65: 66] cm
(20½ [21¼: 22: 22¾: 23¾: 24¾: 25½: 26] in)

SIZE

To fit chest (cm/in)

71-76 81-86 91-97 102-107 112-117 122-127 132-137 142-147 152-157

28-30 32-34 36-38 40-42 44-46 48-50 52-54 56-58 60-62

Actual chest measurement of garment

81 90.5 101.5 111 121 132 141.5 151 162.5

32 35¾ 40 43¾ 47¾ 52 55¾ 59½ 64

YARN

Kidsilk Haze (25gm)

4 4 5 5 6 6 7 7 7

(photographed in Branch 689, Aegean 724 and Burnt Caramel 680)

NEEDLES

1 pair 3mm (no 11) (US 2/3) needles

1 pair 3¼mm (no 10) (US 3) needles

EXTRAS – Tapestry needle for neckband tubular cast-off

TENSION

25 sts and 34 rows to 10 cm measured over st st using 3¼mm (US 3) needles.

WOODHOUSE

Erika Knight



Sample size 81-86 cm (32-34")

13.5 [14: 15.5: 16.5: 18: 19.5: 20: 20.5: 21.5] cm
(5¼ [5½: 6: 6½: 7: 7½: 7¾: 8: 8½] in)

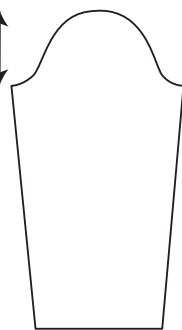

45 [46: 46: 47: 47: 47: 47] cm
(17¾ [18: 18: 18½: 18½: 18½: 18½: 18½: 18½] in)

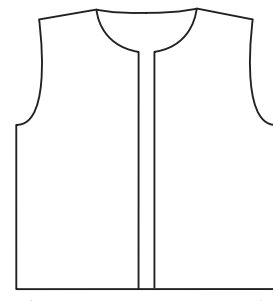

51 [53: 55: 57: 59: 61: 62: 64: 65] cm
(20 [20¾: 21¼: 22¾: 23¼: 24: 24¼: 25¼: 25½] in)

43.5 [49: 54.5: 60: 64.5: 70: 74.5: 80: 84.5] cm
(17 [19¼: 21½: 23½: 25½: 27½: 29¼: 31½: 33¼] in)

SIZE

To fit chest (cm/in)

71-76 81-86 91-97 102-107 112-117 122-127 132-137 142-147 152-157
28-30 32-34 36-38 40-42 44-46 48-50 52-54 56-58 60-62

Actual chest measurement of garment

87.5 98 109 120 129 140 149 160 169
34½ 38½ 43 47¼ 50¾ 55 58¾ 63 66½

YARN

Felted Tweed (50gm)

7 8 9 10 10 11 12 13 14

(photographed in Ancient 172)

NEEDLES

1 pair 3¾mm (no 9) (US 5) needles

1 pair 4mm (no 8) (US 6) needles

Additional 4mm (no 8) (US 6) needle for joining shoulder seams

BUTTONS – 6 x TGB4989 (black coated metal 20mm) from Textile Garden. Please see information page for contact details.

TENSION

22 sts and 30 rows to 10 cm measured over st st using 4mm (US 6) needles.